

# S carab S olutions

## Insulation

Bill Pemberton



A T A Melb Branch presentation

# Average Residential Energy Usage for Australia

Source: AGO 1999

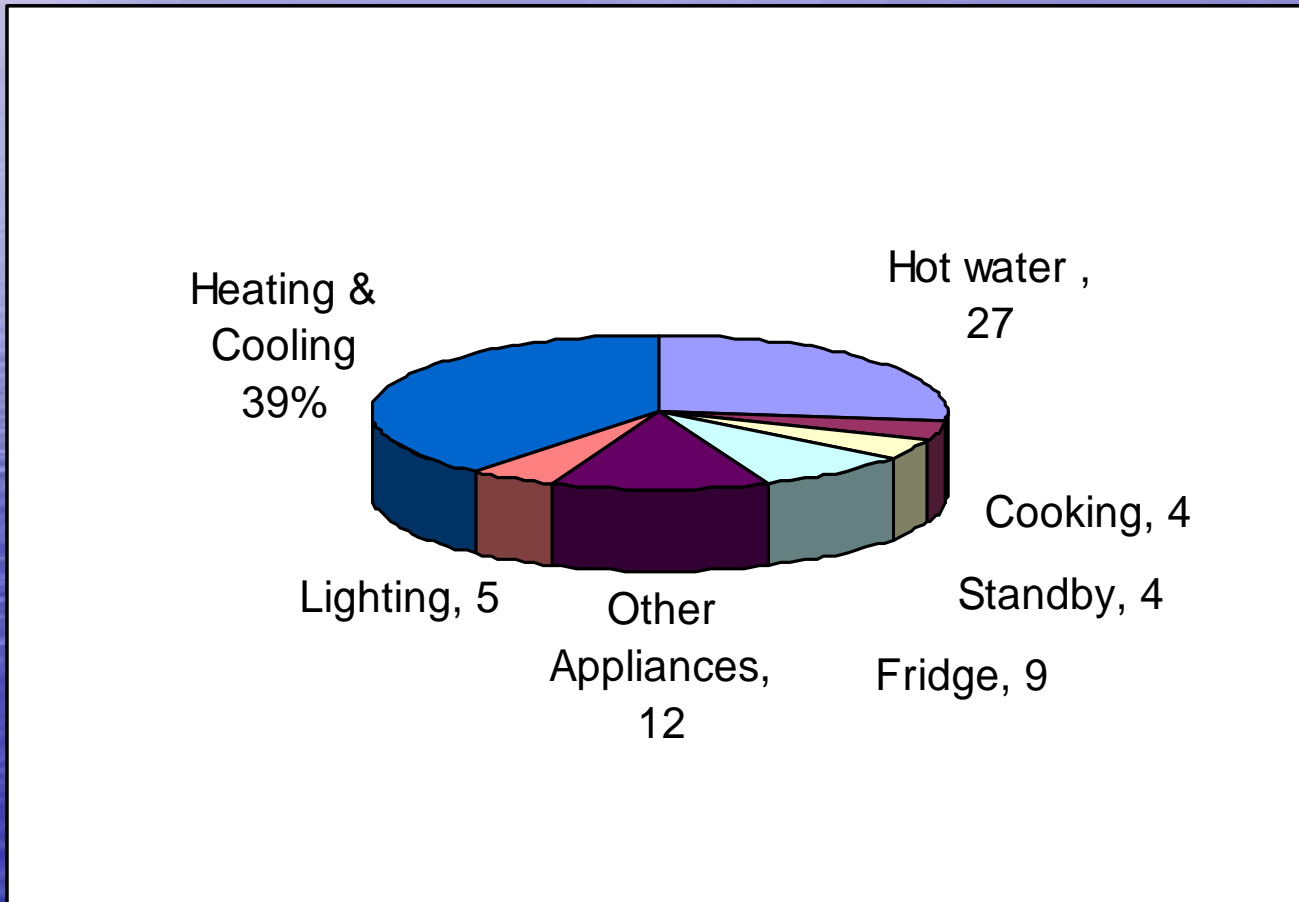

# Energy Basics

- Orientation
- Insulation
- Windows
- Lighting

# Orientation

- North facing living areas
- Minimise east & west glass

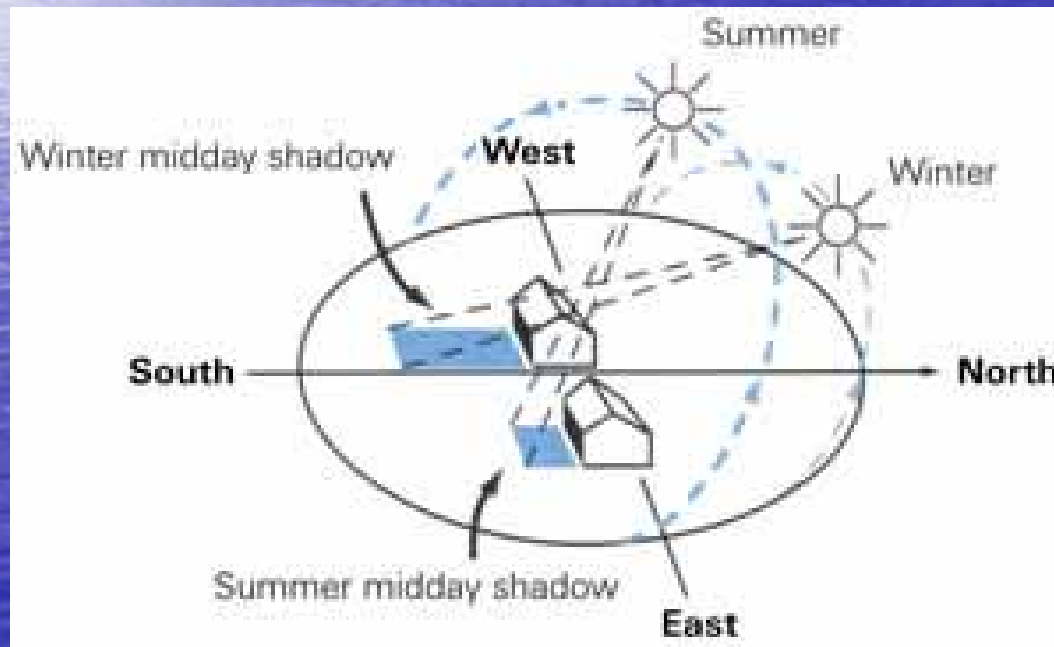

# Insulation

- Insulation - [www.icanz.org.au/tech/insulationhandbook/](http://www.icanz.org.au/tech/insulationhandbook/)  
[www.yourhome.gov.au](http://www.yourhome.gov.au)
- *R value = resistance of heat transfer through the material*
- *Bulk and reflective insulation*

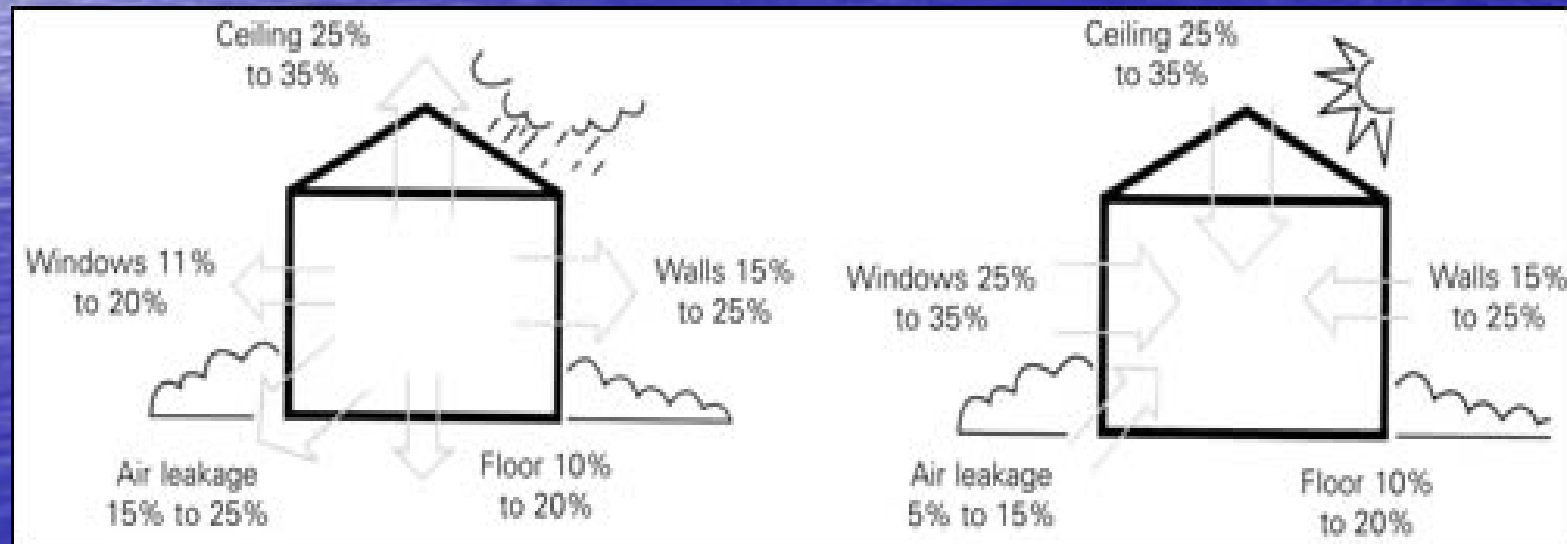

# Bulk Insulation

- Polyester, Poly-wool, Wool, fiberglass, cellulose fibre, polystyrene & Rock Wool

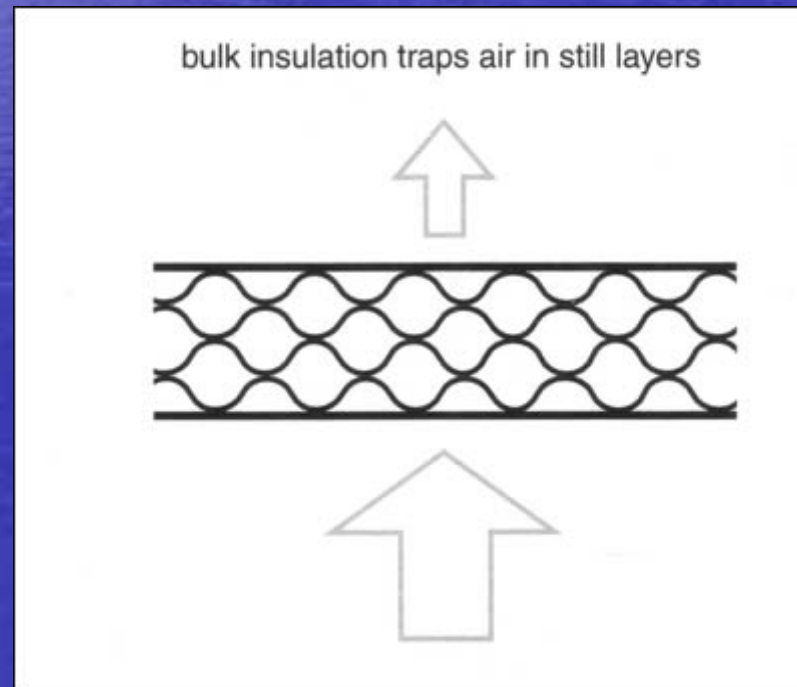

# Reflective Insulation

- Foil products such as Air-cell, concertina foil batts

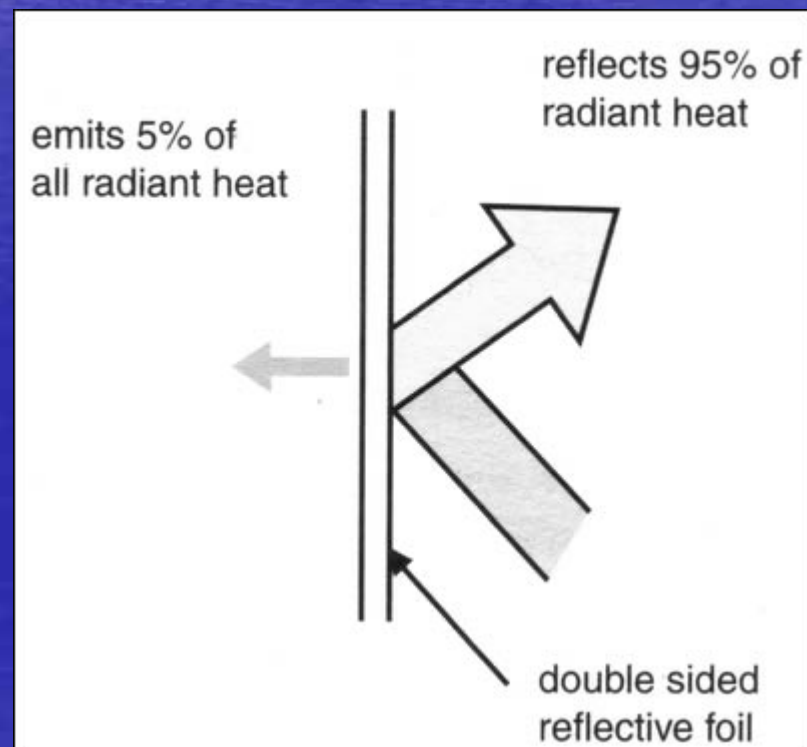

# Insulation

- Reflective Air-cell insulation  
[www.air-cell.com.au](http://www.air-cell.com.au)



# Insulation

- Reflective concertina foil batt insulation  
[www.conertinafoilbatts.com](http://www.conertinafoilbatts.com)



# Insulation Rebate

- [www.sustainability.vic.gov.au](http://www.sustainability.vic.gov.au) then click on our Programs – rebates-Insulation
- *A rebate of 30% off the total cost (including GST) of the installed insulation will be available up to \$300*
- *For concession card holders a rebate amount of 50% of the total cost (including GST) of the installed insulation will be available up to \$500*

# ClearComfort DIY Double glazing

[www.clearcomfort.com.au](http://www.clearcomfort.com.au)

1. Tape



2. Cut & Press



3. Shrink

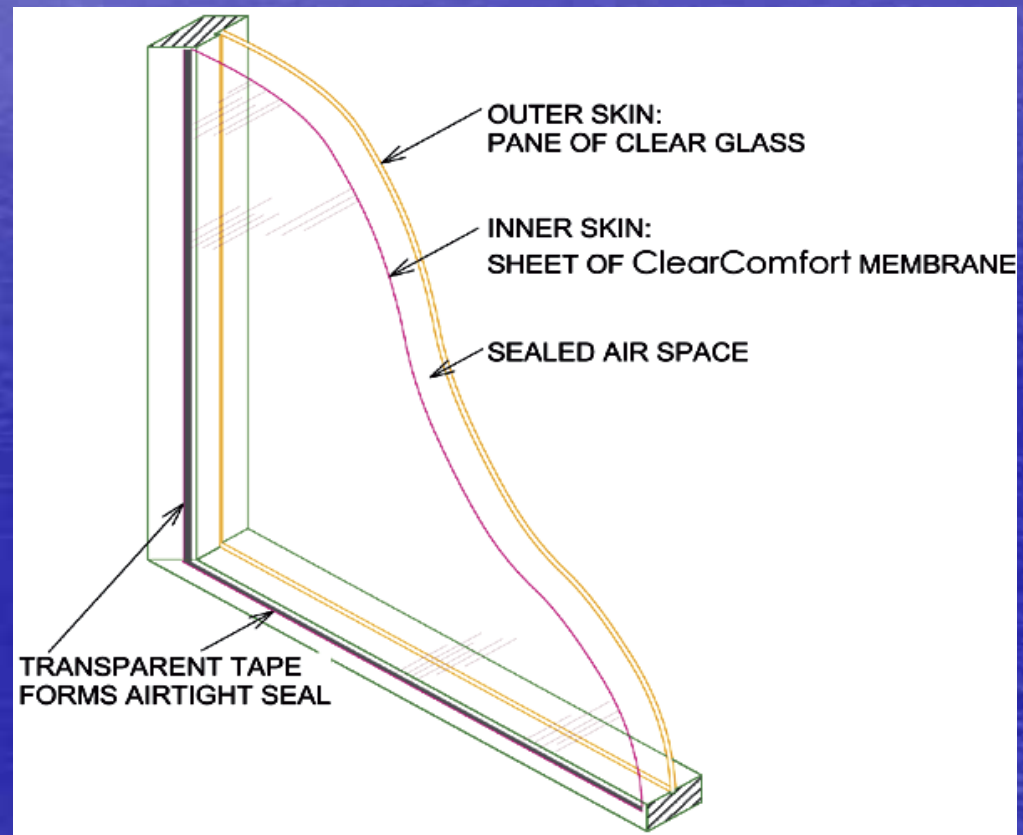
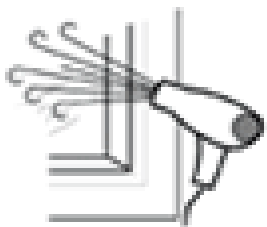

# Magnetite Retrofit Double glazing

[www.magnetite.com.au](http://www.magnetite.com.au)

- 70% reduction in noise
- 60% reduction in heating and cooling costs

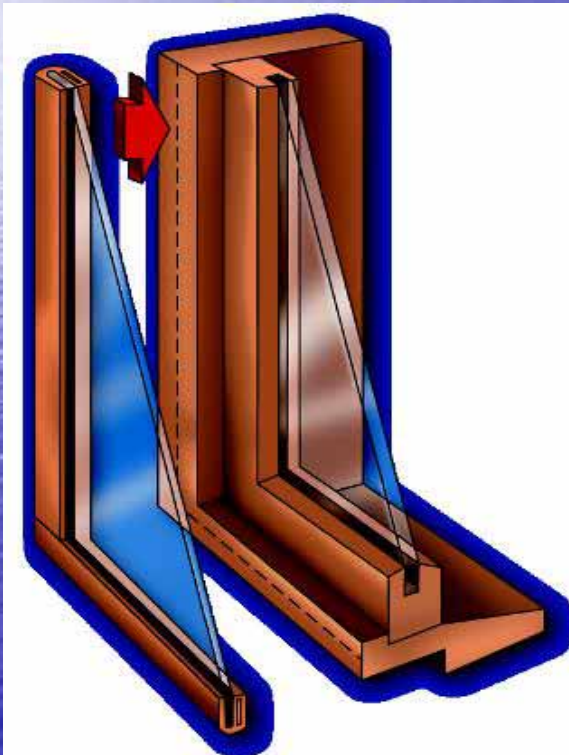

Magnetite has a small unobtrusive frame which fits around the inside perimeter of the frame and the Magnetite panels attach magnetically to the frame.

Magnetite's unobtrusive nature is ideal for leadlight and unique windows. Optical grade acrylic panels keep the aesthetics of a window, so doesn't hinder the view.

Magnetite doesn't require any changes to the original window so it is useful for heritage listed windows. Can be used on louver windows in winter and taken off in summer.

# Renshade



**PERFORATED ALUMINIUM FOIL HOLLAND BLINDS  
FOR WINDOWS**

**KEEPS OUT HEAT - BUT LETS LIGHT IN**

**SEE OUT BUT NOT IN**

**LOWERS COOLING COSTS**

**•RENSHADE stops approximately 85% of all  
inward high temperature radiation**

**[www.concertinafoilbatts.com/renshade.htm](http://www.concertinafoilbatts.com/renshade.htm)**

# Lighting

- Low voltage does not mean low energy
- Avoid the use of halogen down lights
- Cover them with a IsoLite
- Replace them with lower wattage globes



# Seal up drafts

- Door seals and brush
- Draftstopper over ceiling fans



# Building Materials

- Timbercrete\_ - [www.timbercrete.com.au](http://www.timbercrete.com.au)
- *single skin load bearing wall with good insulation properties*
- *Products made from cellulous, cement, sand and a binder*
- *Can be nailed screwed and cut like timber*
- *Termite resistant and has a high fire rating*



# EcoHouse @ Port Phillip Ecocentre

## HOUSE FEATURES:

Passive solar design  
Solar electricity panels  
Solar Hot Water  
5 Star energy rating  
Energy efficient appliances  
Compact Fluorescent Lamps – CFLs  
Pellets & Curtains  
Clear Comfort Window Insulation  
Weather Stripping  
Vestfrost 6 star fridge  
Recycled content Insulation  
Heating/Ventilation system



Drop in or call 9534 0670 to arrange a  
tour or visit [www.ecocentre.com](http://www.ecocentre.com)

# Ceres EcoHouse

- Crn Stewart & Roberts Street, East Brunswick
- at CERES Community Environment Park
- Open to the public every last Saturday of the month, 10am-1pm
  
- Free Entry
- The house has working examples of a:
- Grid interactive PV power system
- Passive solar extension and additions
- Displays of insulation
- Lighting displays
- Energy efficient appliances
- Low embodied energy construction
- Natural floor coverings and finishes
- Urban rainwater harvesting
- Greywater systems
- Solar hotwater & hydronic heating system
- Permaculture garden with low water tolerant plants
- And much more
- A sustainable building consultant is available during opening times to answer any questions
  
- Other attractions open at CERES on Saturdays are the Organic Food & Craft Market, Nursery, Organic Café, and the Bicycle workshop



# 5 Star rating for Renovations

What you need to know about

5 Star for new houses,  
home renovations  
and relocations



*Building Commission*

# Handy web sites for information

For how to information go to the technical manual at

[www.yourhome.gov.au](http://www.yourhome.gov.au)

[www.makeyourhomegreen.vic.gov.au](http://www.makeyourhomegreen.vic.gov.au)

- For products:

[www.environmentshop.com.au](http://www.environmentshop.com.au)

[www.ata.org.au](http://www.ata.org.au)

[www.goingsolar.com.au](http://www.goingsolar.com.au)

For Climate change:

[www.carbonequity.info](http://www.carbonequity.info)

[www.garnautreview.org.au](http://www.garnautreview.org.au)

# Scarab solutions

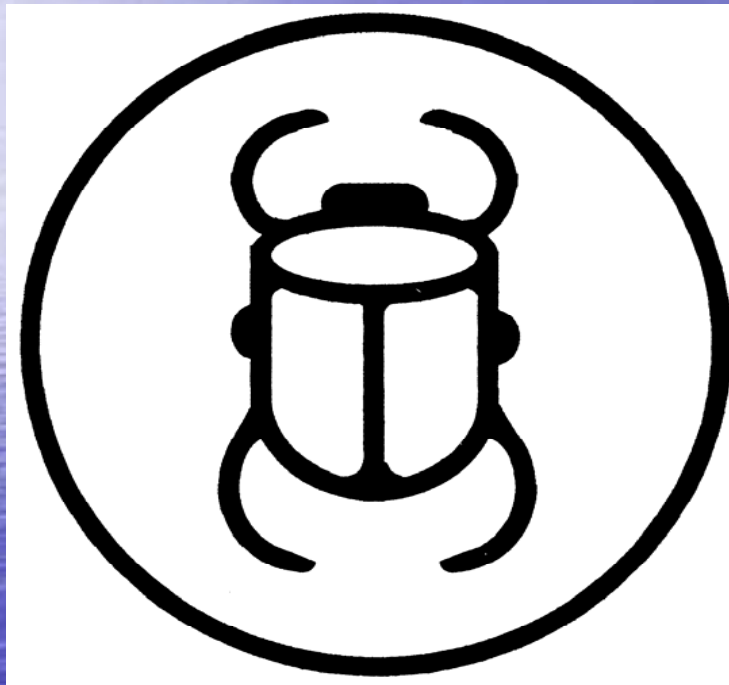

- Bill Pemberton - Director
- Est. 1999
- Providing advice on environmentally sustainable technology to suit your home and budget
- 03 9877 4854
- [scarabsolutions@optusnet.com.au](mailto:scarabsolutions@optusnet.com.au)